



KEEPING A SAFE DISTANCE

# The Safety Solution for Quick Assembly Safety Railings



- PROVIDES A SAFE ENVIRONMENT FOR ALL WORKING ON SITE
- PRE ASSEMBLED UPRIGHTS FOR QUICK INSTALLATION
- SAFETY YELLOW COATING FOR HIGH VISIBILITY
- AVAILABLE IN GALVANISED STEEL OR ALUMINIUM



## Quick Assembly Safety Railing Kits

**KWIK KIT** from stock offer Production, Safety and Maintenance Managers the ability to immediately protect workplace areas as a result of risk assessments or other safety issues. There is no need to weld or bend tubing and low skilled labour can easily install sections.

Pre-assembled uprights not only add to the simplicity but make installations extremely quick to complete, reducing expensive production downtime.

Most guardrail configurations can be constructed using a combination of the alternative kits available.

Building columns suddenly become increasingly visible when the Safety Yellow Column Guards are installed, potentially averting serious structural damage as a result of vehicular impact.

All kits should be secured with proprietary fixing anchors (not included) to suit individual floor constructions.



### Features

- Pre-assembled uprights
- Utilizes market leading KEE KLAMP and KEE LITE safety components
- KEE KLAMP components are fitted with KEE KOAT corrosion protected grubscrews and THREDKOAT recess protection
- 48mm diameter handrails
- Powder coated Safety Yellow to RAL1007 or, aesthetically pleasing self colour aluminium
- Satisfies 0.36 kN/m as stated in BS6180
- Variable angle adjustment for Step and Ramp kits
- Safety gloves included for installers protection.

### Benefits

- Safe environment for all working on site
- High visibility "Safety Yellow" powder coating
- No welding, bending or threading required
- Versatile modular construction
- Sections can be added and changed as required
- Simple installation using the hexagon key provided
- Alternative baseplate availability.



# Model Types



**KWIK KIT** Quick Assembly Safety Railing Kits are available in nine model types. Steel models are supplied with handrailing and uprights powder coated in SAFETY YELLOW to RAL1007, fittings are Hot dip Galvanised only. Aluminium models have self colour aluminium handrailing and fittings.

Owing to unknown floor conditions fixing anchors are not provided.

## Steel Straight Kit

## KwikSS

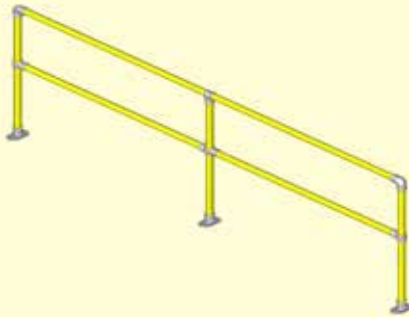

**KwikSS** is a straight section of 48.3mm diameter galvanised steel handrailing 3000mm long, with three uprights and flat fix baseplates.

## Aluminium Straight Kit

## KwikAS



**KwikAS** is a straight section of 48.3mm diameter self colour aluminium handrailing 3000mm long, with three uprights and flat fix baseplates.

## Steel Corner Kit

## KwikSC

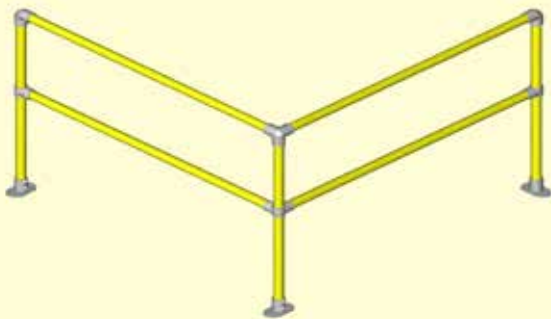

**KwikSC** is a corner section of 48.3mm diameter galvanised steel handrailing 1500mm long x 1500mm long, with three uprights and flat fix baseplates..

## Aluminium Corner Kit

## KwikAC

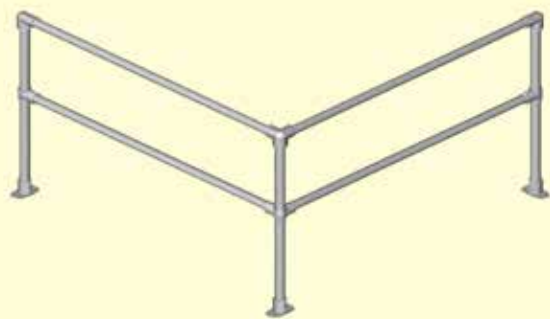

**KwikAC** is a straight section of 48.3mm diameter self colour aluminium handrailing 3000mm long, with three uprights and flat fix baseplates.

## Steel Extension Kit

## KwikSE

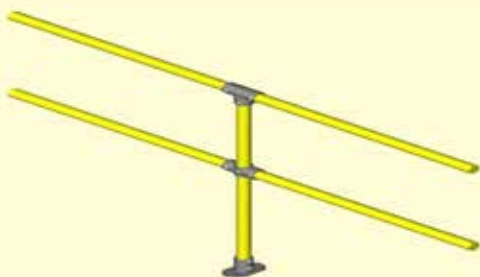

**KwikSE** is a kit designed to be used in conjunction with **KwikSS** and **KwikSC** where an extended section of handrail is required, comprising 48.3mm diameter galvanised steel handrailing 3000mm long with one upright and a flat fix baseplate.

## Aluminium Extension Kit

## KwikAE

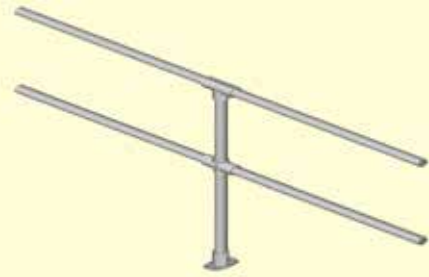

**KwikAE** is a kit designed to be used in conjunction with **KwikAS** and **KwikAC** where an extended section of handrail is required, comprising 48.3mm diameter self colour aluminium handrailing 3000mm long with one upright and a flat fix baseplate.



# KWIK KIT Model Types

## Steel Step Kit

### KwikS3045

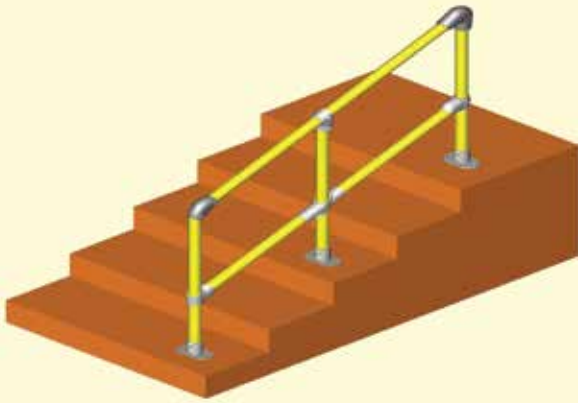

**KwikS3045** is a step section of 48.3mm diameter galvanised steel handrailing 3000mm long with three uprights and flat fix baseplates. The handrail accommodates variable step inclines from 30–45 degrees.

## Steel Ramp Kit

### KwikS011

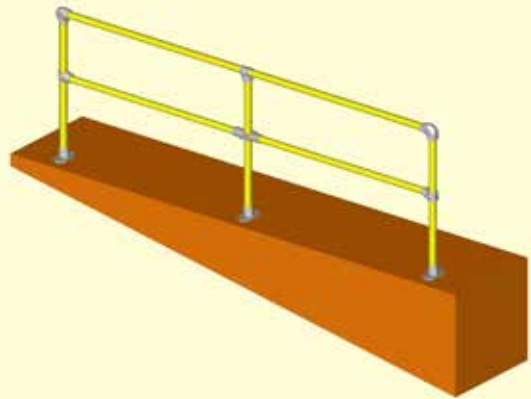

**KwikS011** is a ramp section of 48.3mm diameter galvanised steel handrailing 3000mm long with three uprights and angled flat fix baseplates. The handrail accommodates variable ramp inclines from 0–11 degrees.

## Column Guard Kit

### KwikCG1

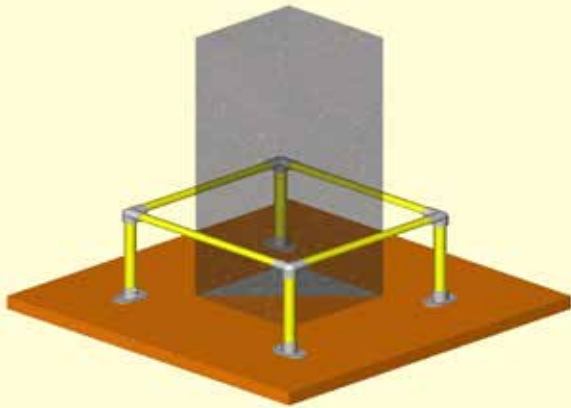

**KwikCG1** is a Column Guard manufactured from 48.3mm diameter galvanised steel tube, 800mm square with four uprights and flat fix baseplates. The horizontal rails are designed long and can be cut down on site to suit actual column dimensions.

## Alternative Bases Options



### Toe Board Option

#### **Kee Klamp® Type 69.**

Stainless steel hardware included. Easy to install with no drilling or welding.



### Ground Socket Option

#### **Kee Klamp® Type 66.**

Designed for concrete installations where uprights are required to be removable. It incorporates a socket set screw fixing on top of flange and can be supplied with a plug to fill the hole when the tube is removed.

*Note: Alternative bases may affect final price.*



Kee Safety Limited  
Cradley Business Park  
Overend Road  
Cradley Heath  
B64 7DW

Tel: 01384 632 188  
Fax: 01384 632 192

Email: [sales@keesafety.com](mailto:sales@keesafety.com)  
[www.keesafety.co.uk](http://www.keesafety.co.uk)